



CATALOGUE

BOSS

+ d'info: 04 94 44 28 05
www.lignes-bureau.com

LE MEILLEUR DU MOBILIER DE BUREAU PROFESSIONNEL DESIGN

design:
Gianantonio Perin
Monica Fernandes

BOSS meuble les espaces de direction avec élégance et prestige grâce à son design contemporain.

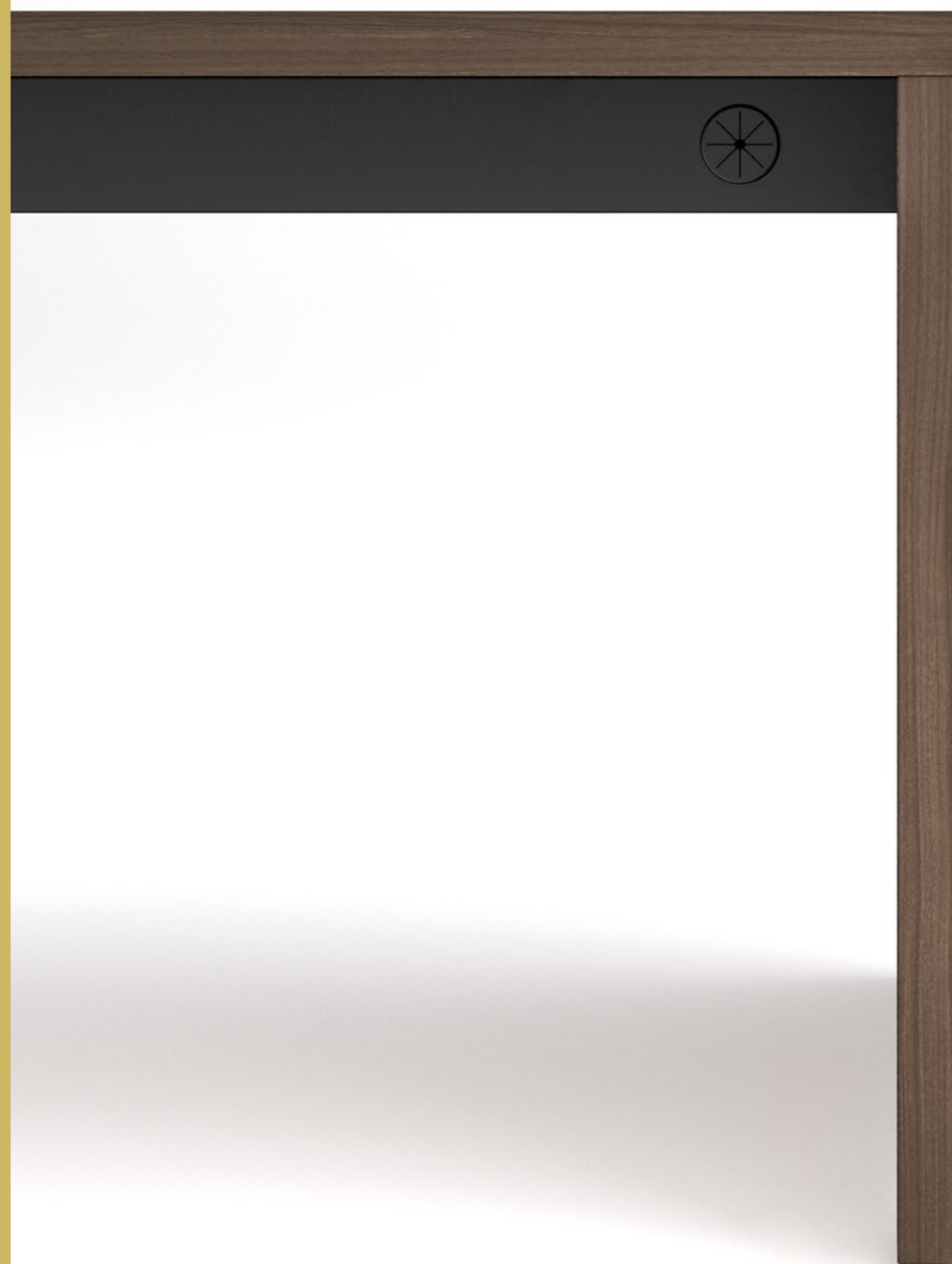

+ d'info: 04 94 44 28 05
www.lignes-bureau.com





Le compartiment avant du meuble de service (crédence) est ouvert.
Il est disponible en différentes finitions et couleurs, et donne au bureau BOSS légèreté et dynamisme !



Le sous-main optionnel existe en 2 versions:

- ✓ un modèle posé sur la table,
- ✓ un sous-main coulissant avec compartiment pour ranger des stylos et se connecter sur prises USB 5V et alimentation*.



Bureau avec insert en Cuir ou en Peau écologique



Bureau avec plateau mélaminé.

Le retour avec réglage électrique en hauteur est également disponible, pour un poste de travail contemporain et ergonomique.



+ d'info: **04 94 44 28 05**
www.lignes-bureau.com

+ d'info: 04 94 44 28 05
www.lignes-bureau.com





+ d'info: 04 94 44 28 05
www.lignes-bureau.com



+ d'info: 04 94 44 28 05
www.lignes-bureau.com



Les armoires élégantes et originales se conjuguent avec différents matériaux, décors et dimensions



melaminico, melamine, mélamine,
melamin, melamina



laccato opaco, lacquered matt, lacqué mat
matt lackiert, lacado mate

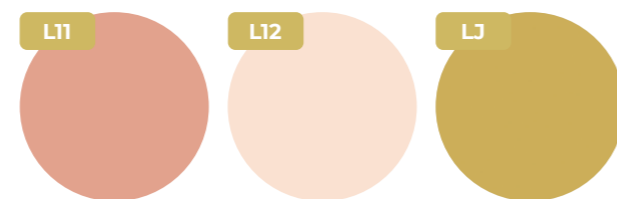
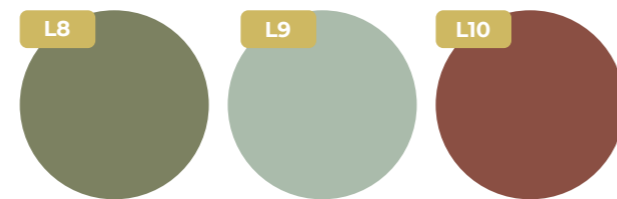
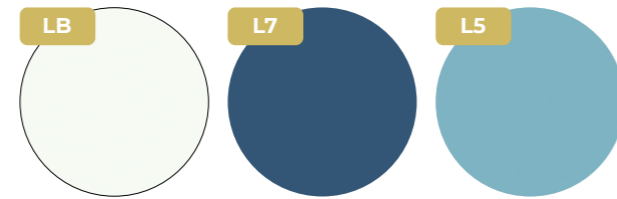
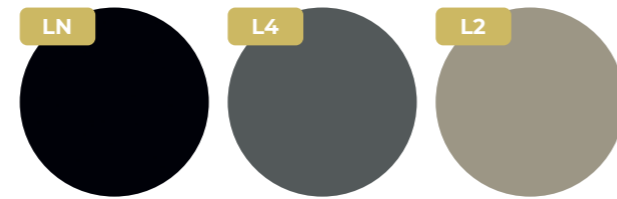

vetro temperato, tempered glass, verre trempé,
sicherheitsglas, vidrio templado

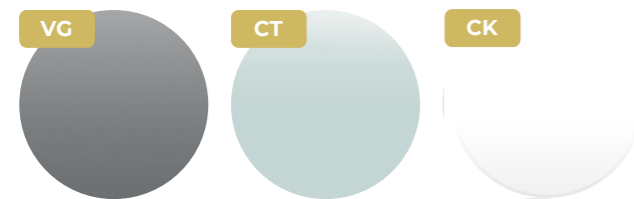

vetro temperato retrolaccato, back-lacquered tempered glass, verre retro-lacqué trempé,
sicherheitsglas rückseitig lackiert, vidrio retrolacado templado

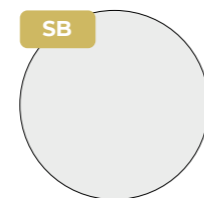
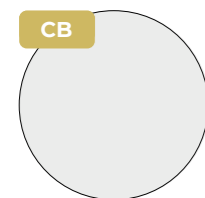
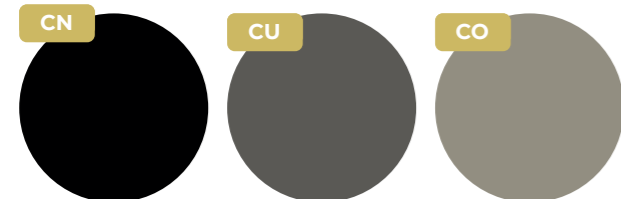

C_ (lucido · glossy · brillant · poliert · brillo)

S_ (opaco · matt · opaque · matt · mate)

pelle, leather, cuir,
Leder, piel



pelle ecologica, eco-leather, peau écologique,
Kunstleder, eco-piel

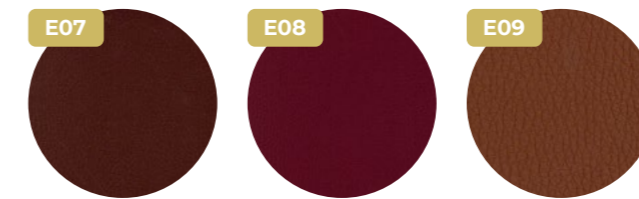
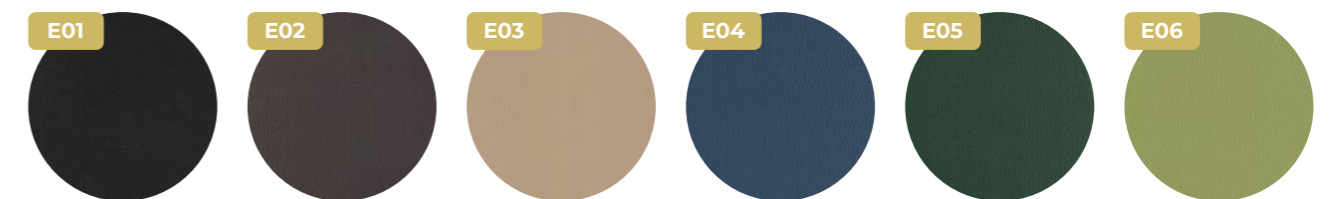

dettaglio cucitura inserto in pelle, leather insert seam detail, détail de couture d'insertion de cuir,
Nahtdetail mit Ledereinsatz, detalle de costura de inserción de cuero



+ d'info: 04 94 44 28 05
www.lignes-bureau.com

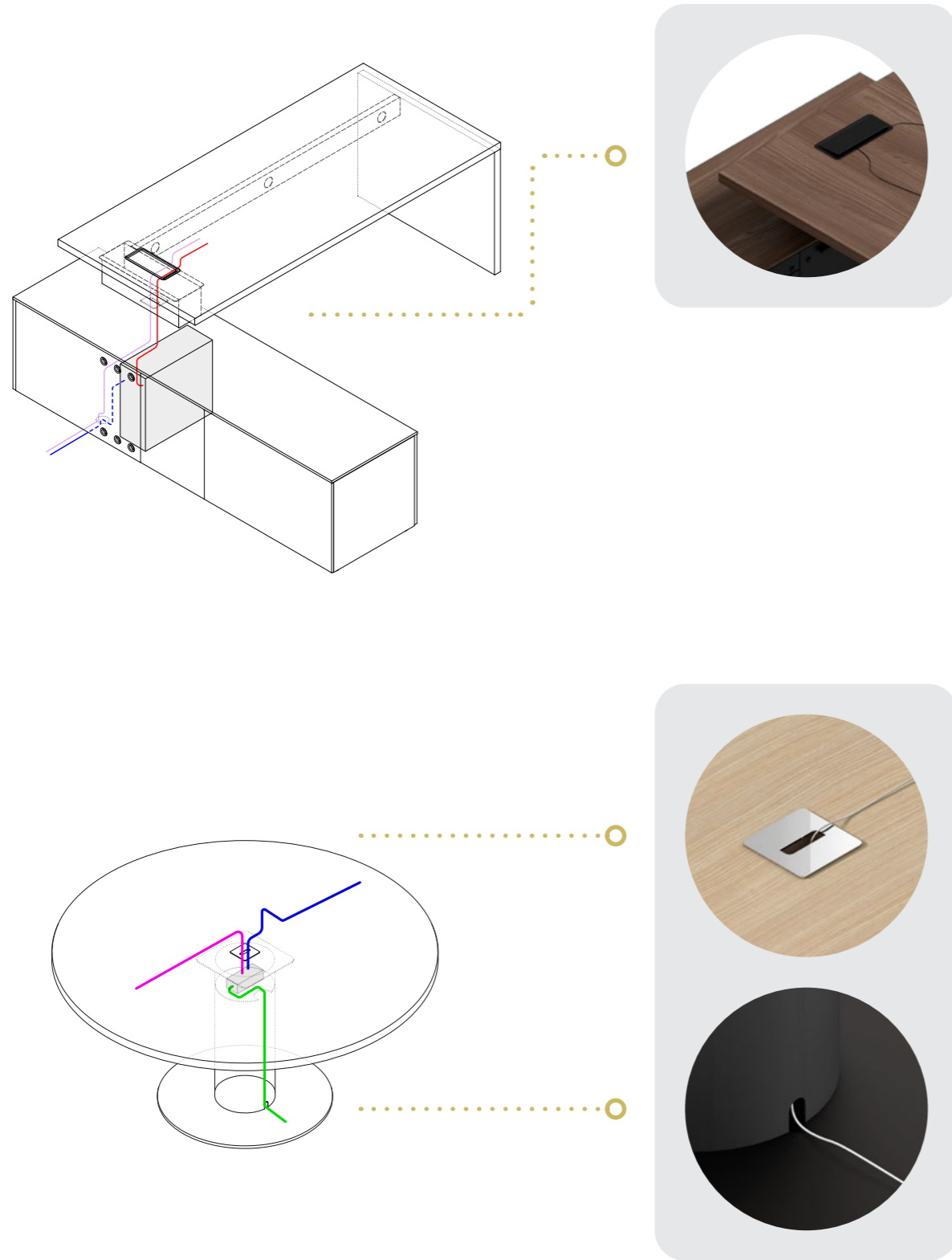

h 74 cm

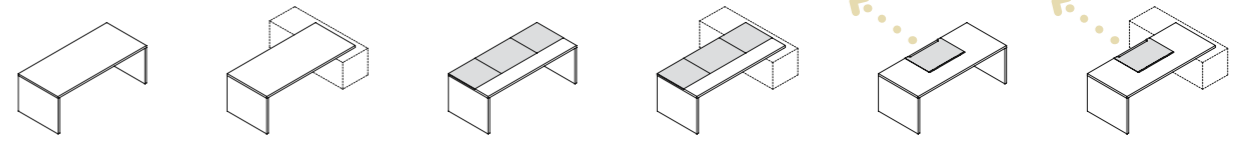

w 180-200 cm
d 90 cm

h 74 cm

h 67÷132 cm

h 30 cm

h 40 cm

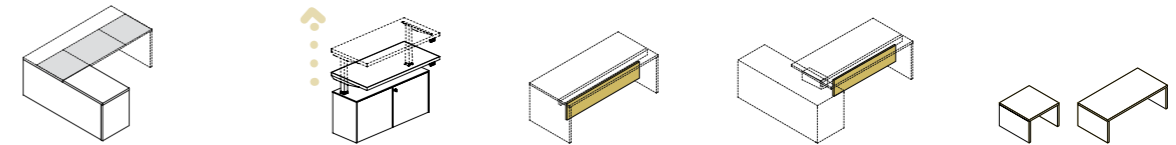

w 180-200 cm
d 180 cm

w 122,5 cm
d 60 cm

w 120÷160 cm
d 1,8 cm

w 60-120 cm
d 60 cm

h 54 cm

h 58,5 cm

h 54 cm

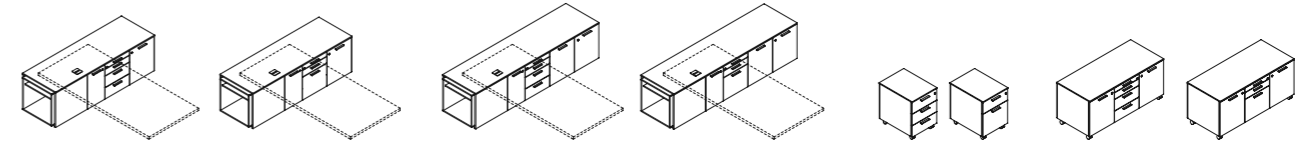

w 170,2 cm
d 56,2 cm

w 211,9 cm
d 56,2 cm

w 41,7 cm
d 56,2 cm

w 125,3 cm
d 56,2 cm

h 73,7 cm

h 124,9 cm

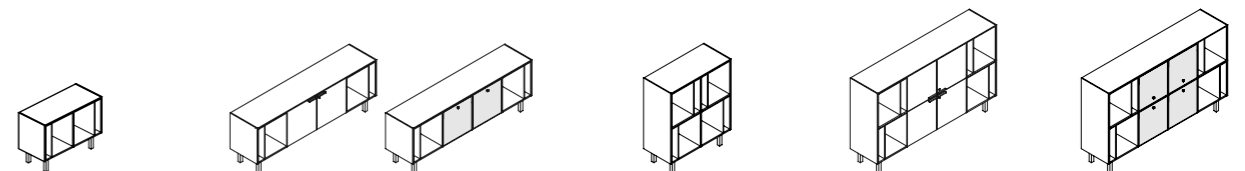

w 102,4 cm
d 46 cm

w 202,4 cm
d 46 cm

w 102,4 cm
d 46 cm

w 202,4 cm
d 46 cm



h 74 cm



∅ 120 cm

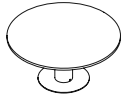

∅ 140-160 cm

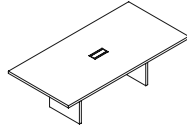

w 240 cm
d 120 cm

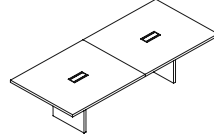

w 280 cm
d 120 cm

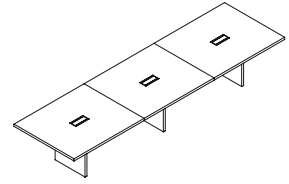

w 420 cm
d 120 cm

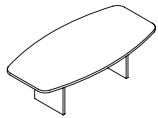

w 240 cm
d 120 cm

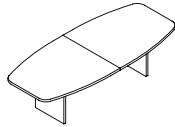

w 280 cm
d 120 cm

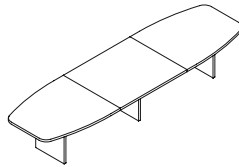

w 420 cm
d 120 cm

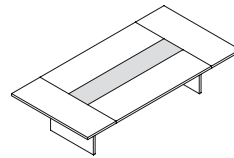

w 320 cm
d 160 cm

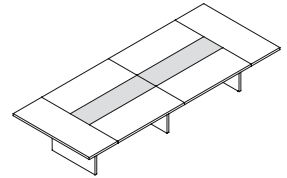

w 400-480 cm
d 160 cm



h 78,6 - 117 - 155,4 - 193,8 cm

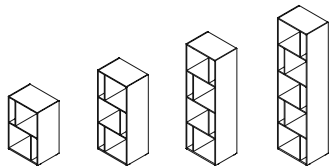

w 50 cm
d 36,3 cm

h 76,8 - 115,2 - 153,6 - 192 cm

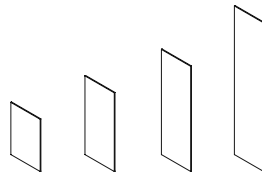

w 50 cm
d 1,2 cm

